

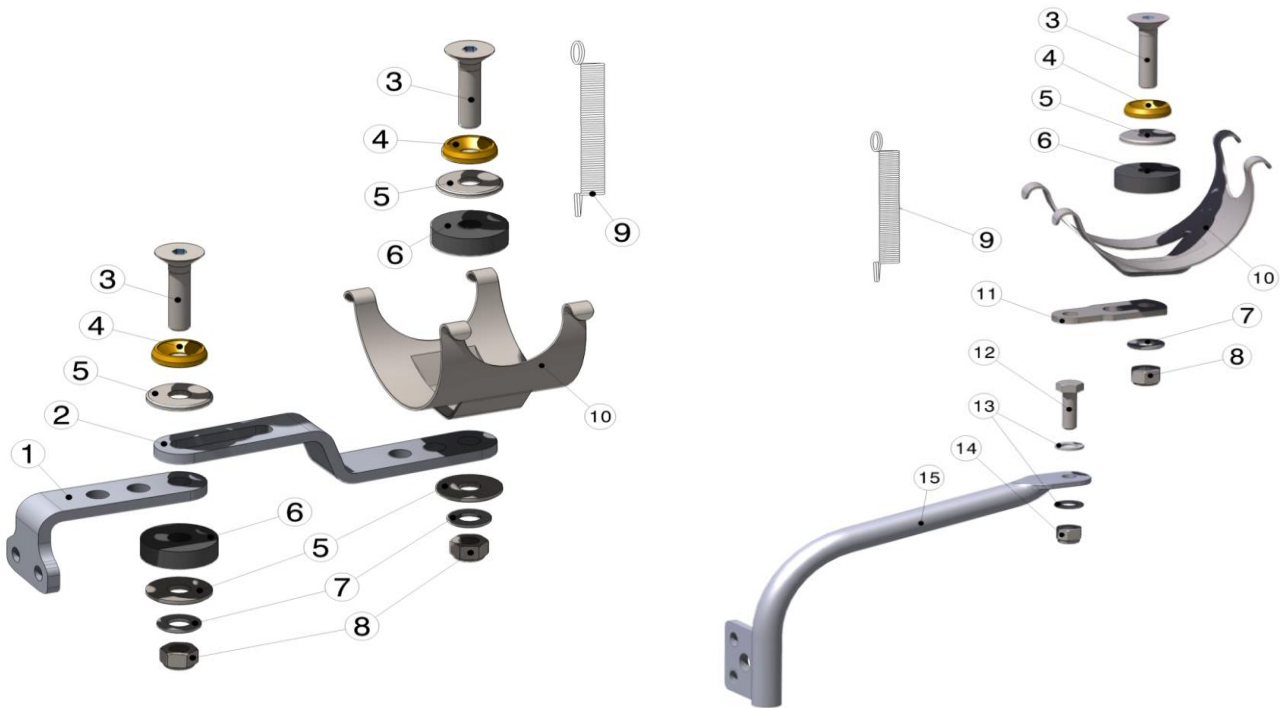

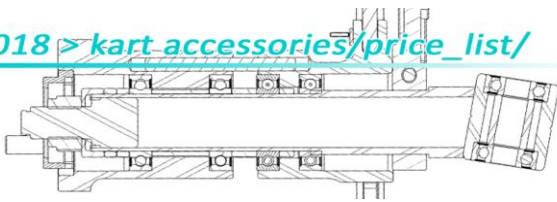

## EXHAUST SUPPORTS

code	description	希望小売価格(税別)
CS-ENG-SILHLD	UNIVERSAL SILENCER HOLDER	 10,400

1	ENG-SILHLDBRK	UNIVERSAL EXHAUST SILENCER SUPPORT WHITE GALVANIZED	2,600
2	ENG-SILHLDSUPKZ	SILENCER HOLDER SUPPORT WHITE GALVANIZED	2,600
3	KIT-VT-SC1045SH	SCREW COUNTERSUNK HEAD M10x45MM	50
4	KIT-VT-WS1025CH	WASHER COUNTERSUNK Ø10x25MM TITAN GOLD ANODIZED	200
5	KIT-VT-WS1030	WASHER Ø10x30MM	30
6	KIT-VT-SB1035	SILENTBLOCK Ø10xØ35xH10.5MM	510
7	KIT-VT-WS1020	WASHER Ø10x20MM	30
8	KIT-VT-NT10SH	NUT SELFLOCK HIGH M10	40
9	KIT-ENG-SILSPR	SILENCER HOLDER SPRING	510
10	ENG-SILHLDR	SILENCER HOLDER - WHITE GALVANIZED	1,900
11	ENG-SILBRKSPD	SPEEDY / PICCOLO SILENCER HOLDER BRACKET WHITE GALVANIZED	1,900
12	KIT-VT-SC0825HH	SCREW HEXAGON HEAD M8x25MM	50
13	KIT-VT-WS0816	WASHER Ø8x16MM	30
14	KIT-VT-NT08SH	NUT SELFLOCK HIGH M8	40
15	CS-ENG-SUPLFTSPD	SPEEDY / PICCOLO SILENCER SUPPORT - CHROMED	5,300



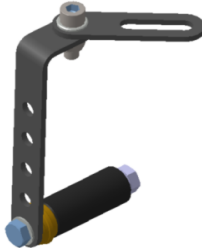

ENG-SILRTXSPDRGH	MINIKART ROTAX RIGHT SILENCER HOLDER		2,600
ENG-SILRTXSPDLFT	MINIKART ROTAX LEFT SILENCER HOLDER		2,600
ENG-DD2SHPLT	DD2 SILENCER HOLDER PLATE		2,600
CS-ENG-SILDD2RGH	DD2 SILENCER HOLDER SUPPORT KIT Ø30MM		10,400
CS-ENG-SILDD2RGH32	DD2 SILENCER HOLDER SUPPORT KIT Ø32MM		